

# IN PURSUIT OF PERFECTION

Tealth Foshan Medical Equipment Co.,Ltd

Address:No. 4, Qiling Road, Lutang Industrial Zone, Luocun, Shishan  
Town, Nanhai District, Foshan, Guangdong 528226, China

Tel:0086-757-86436722

Fax:0086-757-86436987

Email:sales@tealthfoshan.com

website:www.tealthhandpiece.com

Catalogue pictures and parameters for reference only, we reserve the right to  
make any improvements on products design without advance notice.



WeChat Official Account



Web QR code

# NONU

Excellence Handpiece  
Manufacturer **CE** 1639 **ISO** 13485

# TEALTH

- 01 /** Company profile
- 02 /** Development History
- 04 /** Internal irrigation low speed HP
- 10 /** External irrigation low speed HP
- 12 /** Surgical handpiece
- 14 /** Increasing dental handpiece
- 16 /** Implant contra angle
- 18 /** IPR Contra angle
- 20 /** High speed dental handpiece
- 29 /** Torque Wrench
- 30 /** Electric micromotor

## Company profile



Tealth Foshan Medical Equipment Co. Ltd. is a leading dental equipment manufacturer in China. Established In 2012, Tealth offers high-quality and affordable dental handpieces, with CE certificate, and ISO13485 certificate.

All equipments are designed and self-produced within its headquarters using imported machinery from Japan and Europe.

At Tealth, we are committed to providing efficient, safe, and comfortable dental handpieces with friendly customer service and professional product support.

## Certificates





2022



# DEVELOPMENT HISTORY



# INTERNAL IRRIGATION LOW SPEED DENTAL HANDPIECE

- CA or FG head easy changeable



**01** Polishing  
Applicable bur: prophy cup  
φ2.35mm



**02** Fine  
Applicable bur: FG  
φ1.60mm





# S01 1:1 LIGHT KIT

CE: 1020L-M4



- Internal irrigation
- Rotation speed: 18,000-20,000r/min
- Applicable bur:  $\Phi 2.35\text{mm}/\Phi 1.60\text{mm}$
- Noise :  $\leq 70\text{dB}$
- Chuck type: Push button
- LED contra angle (E generator)

# S10 1:1 NON-LIGHT KIT

CE: 1020-M4



The separated design of water pipe and air tube for perfect cooling

- Internal irrigation
- Chuck type: Push button
- Noise :  $\leq 70\text{dB}$
- Rotation speed: 18,000-20,000r/min
- Applicable bur:  $\Phi 2.35\text{mm}/\Phi 1.60\text{mm}$

Core parts made by high-precision stainless steel, more reliable

High quality FKM sealing provide durable function

# S13 1:1 FIBER OPTIC LOW SPEED KIT

CE: 1020L-M4



- Fiber optic internal irrigation
- Applicable bur:  $\Phi 2.35\text{mm}/\Phi 1.60\text{mm}$
- Noise :  $\leq 70\text{dB}$
- Rotation speed: 18,000-20,000r/min
- Chuck type: Push button

## Contra Angle

ORDER: CIF-01C  
CE: 1020L-M4

- FIBER OPTIC
- Push button
- CA  $\Phi 2.35\text{mm}/\text{FG } \Phi 1.60\text{mm}$
- Max speed: 20,000 or 40,000 r/min



## Contra Angle

ORDER: CIL-01C  
CE: 1020L-M4

- LED
- Push button
- CA  $\Phi 2.35\text{mm}/\text{FG } \Phi 1.60\text{mm}$
- Max speed: 20,000 or 40,000 r/min



## Contra Angle

ORDER: CIL-02C  
CE: 1020L-M4

- LED
- Push button
- CA  $\Phi 2.35\text{mm}/\text{FG } \Phi 1.60\text{mm}$
- Max speed: 20,000 or 40,000 r/min



## Contra Angle

ORDER: CIN-01C  
CE: 1020L-M4

- Push button
- CA  $\Phi 2.35\text{mm}/\text{FG } \Phi 1.60\text{mm}$
- Max speed: 20,000 or 40,000 r/min





**Δ Air Motor**

ORDER: MIF-01C  
CE: 1020L-M4



FIBER OPTIC  
Max speed:20,000 r/min  
Air pressure:245-392 kPa  
Atomize water pressure: 200kPa  
Atomize air pressure: 200kPa

**Straight Head**

ORDER: SIF-01C  
CE: 1020L-M4



FIBER OPTIC  
Swivel ring type  
CA 2.35mm  
Max speed:40,000 r/min

**Δ Air Motor**

ORDER: MIN-01C  
CE: 1020-M4



Max speed:20,000 r/min  
Air pressure:245-392 kPa  
Atomize water pressure: 200kPa  
Atomize air pressure: 200kPa

**Straight Head**

ORDER: SIN-01C  
CE: 1020-M4

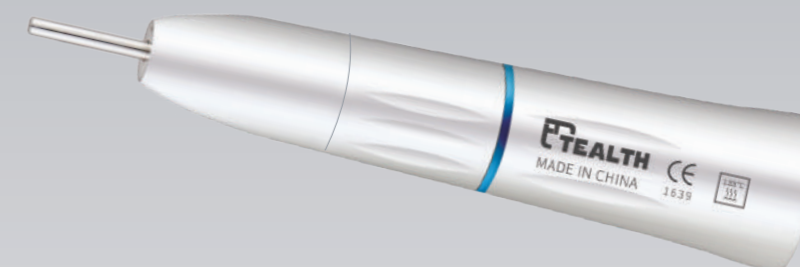

Swivel ring type  
CA Φ 2.35mm  
Max speed:40,000 r/min

**Δ Air Motor**

ORDER: BIN-01C  
CE: 1020-B2



Max speed:20,000 r/min  
Air pressure:245-392 kPa  
Atomize water pressure: 200kPa  
Atomize air pressure: 200kPa

**Straight Head**

ORDER: SIN-03C  
CE: 1020-M4

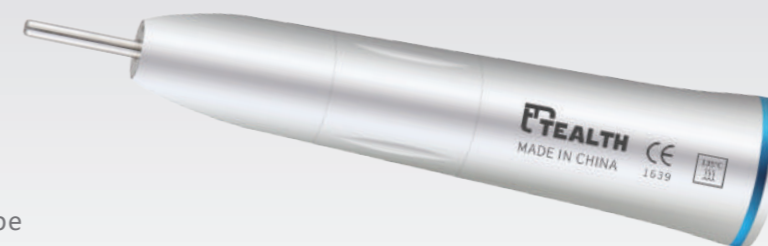

Swivel ring type  
CA Φ 2.35mm  
Max speed:40,000 r/min

# S06

LATCH TYPE/  
PUSH BUTTON KIT

CE: 1024-B2



# S08

- Air pressure:245-392kPa
- Noise : $\leq$ 70dB
- Rotation speed:16,000-20,000r/min
- Chuck type: Latch type/Push button





**Contra Angle**

ORDER: CEL-01C  
CE: 1024-B2



Latch type  
CA  $\Phi$  2.35mm  
Max speed: 20,000 r/min



**Contra Angle**

ORDER: CEN-02C  
CE: 1021-M4

Push button  
CA  $\Phi$  2.35mm  
Max speed: 20,000 r/min



**Contra Angle**

ORDER: CEN-21C  
CE: 1024-B2

Latch type  
CA  $\Phi$  2.35mm  
Max speed: 20,000 r/min



**Contra Angle**

ORDER: CEN-01C  
CE: 1024-B2

Push button  
CA  $\Phi$  2.35mm  
Max speed: 20,000 r/min



**Contra Angle**

ORDER: CEN-22C  
CE: 1021-M4

Latch type  
CA  $\Phi$  2.35mm  
Max speed: 20,000 r/min



**Contra Angle**

ORDER: CEN-11C  
CE: 1024-B2

Push button  
FG  $\Phi$  1.60mm  
Max speed: 20,000 r/min



**Contra Angle**

ORDER: CEN-08C  
CE: 1024-B2

Push button  
CA  $\Phi$  2.35mm  
Max speed: 20,000 r/min



**Polishi Contra Angle**

ORDER: CEN-31C  
CE: 1024-B2

For screw type prophy cup  
Max speed: 25,000 r/min



## Air Motor

ORDER: MEN-02C  
CE: 1024-B2



Max speed:20,000 r/min  
Air pressure:245-392 kPa  
Atomize water pressure: 200kPa  
Atomize air pressure: 200kPa

## Air Motor

ORDER: BEN-02C  
CE: 1024-B2



Max speed:20,000 r/min  
Air pressure:245-392 kPa  
Atomize water pressure: 200kPa  
Atomize air pressure: 200kPa

## Air Motor

ORDER: MEN-08C  
CE: 1024-B2  
ORDER: BEN-08C  
CE: 1024-B2



Max speed:20,000 r/min  
Air pressure:245-392 kPa  
Atomize water pressure: 200kPa  
Atomize air pressure: 200kPa

## Straight Head

ORDER: SEN-01C  
CE: 1021-M4

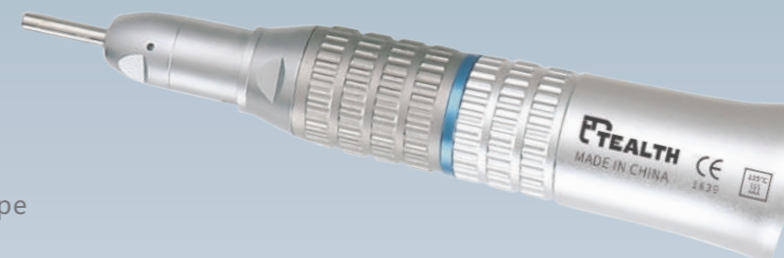

Swivel ring type  
CA  $\Phi$ 2.35mm  
Max speed:20,000 r/min

## Straight Head

ORDER: SEN-02C  
CE: 1024-B2



Swivel ring type  
CA  $\Phi$ 2.35mm  
Max speed:20,000 r/min

## Straight Head

ORDER: SEN-03C  
CE: 1024-B2

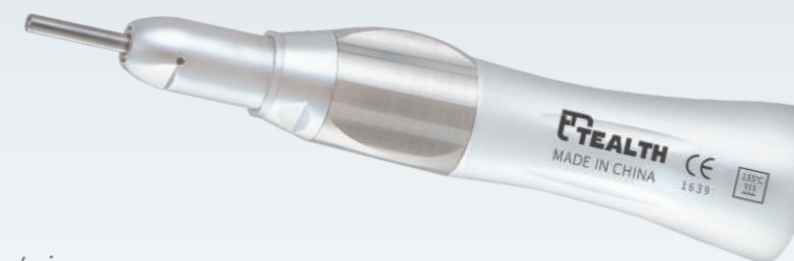

Swivel ring type  
CA  $\Phi$ 2.35mm  
Max speed:20,000 r/min

## Straight Head

ORDER: SEN-08C  
CE: 1024-B2

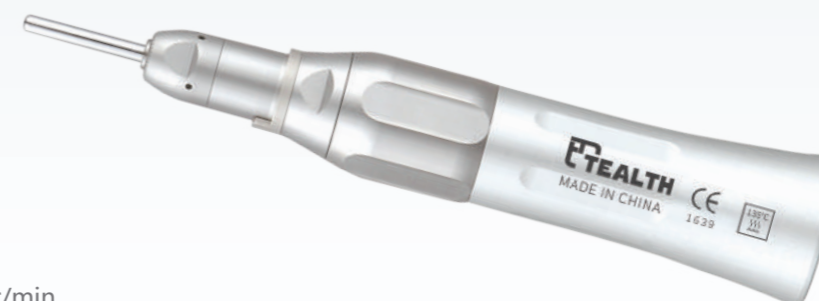

Swivel ring type  
CA  $\Phi$ 2.35mm  
Max speed:20,000 r/min



# SEN-09

INCREASING  
STRAIGHT HEAD

- CE: 1024-B2
- Swivel ring type
  - Gear ratio: 1:2
  - Φ2.35mm
  - Max speed:120,000 r/min



# SIN-02C

SURGICAL  
STRAIGHT HEAD

- CE: 1020-M4
- Swivel ring type
  - Gear ratio: 1:1
  - Φ2.35mm
  - Max speed:40,000 r/min
  - Internal & external spray



## 20° Surgical Straight Head

ORDER: SEN-10C  
CE: 1024-B2

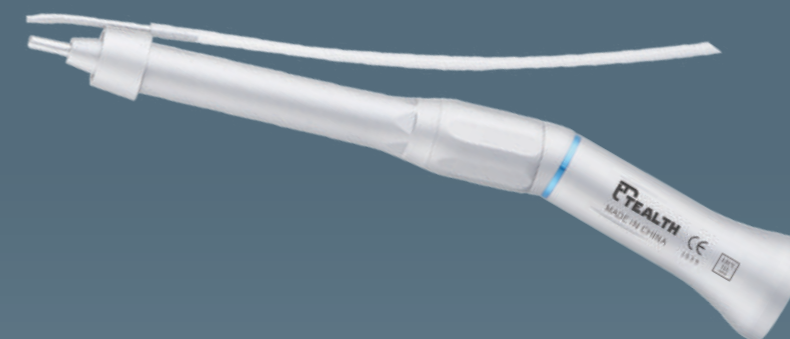

Swivel ring type  
Gear ratio: 1:1  
Φ2.35mm  
Max speed:20,000 r/min

## Surgical Straight Head

ORDER: SEN-05C  
CE: 1024-B2



Swivel ring type  
Gear ratio: 1:1  
Φ2.35mm  
Max speed:20,000 r/min

## Surgical Straight Head

ORDER: SEN-07C  
CE: 1024-B2

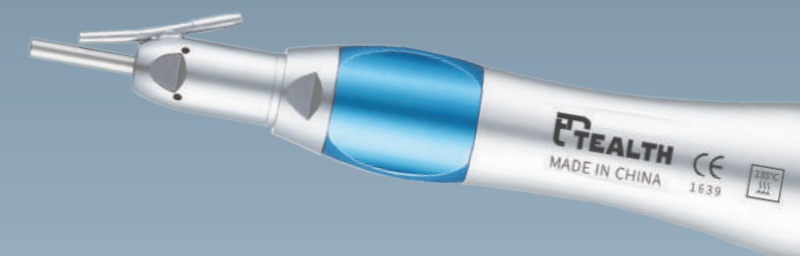

Swivel ring type  
Gear ratio: 1:1  
Φ2.35mm  
Max speed:20,000 r/min

## Straight Head

ORDER: SEN-04C  
CE: 1024-B2



Swivel ring type  
CA Φ2.35mm  
Max speed:20,000 r/min

**Increasing dental handpiece**

104F-01C  CE: 1020L-M4

**1:4.2 Fiber optic surgical contra angle**

- Rotation speed: 168,000r/min
- Noise: <62dB
- External irrigation, triple water spray
- Chuck type: Push button
- Water pressure: 0.2-0.23Mpa
- Stainless steel



105F-01C 

**1:5 Fiber optic contra angle** CE: 1020L-M4

- 1:5 Increasing contra angle stable light source
- Internal irrigation, quadruple water spray
- Applicable bur:  $\phi 1.60\text{mm}$





## 💡 FIBER OPTIC

ORDER: R20F-01C  
CE: 1020L-M4

Torque: 70N.cm



💡 ORDER: R20L-01C  
CE: 1020L-M4

Torque: ≤70N cm



ORDER: R20N-04C  
CE: 3203CH

Torque: 70N.cm  
Easy detachable structure



ORDER: R20N-02C  
CE: 3201CH

Torque: 55N.cm  
Easy detachable head



ORDER: R20N-01C  
CE: 3200CH

Torque: 55N.cm



Push button  
CA φ2.35mm  
Max speed: 2,000r/min  
Gear ratio:20:1  
Sterilization temperature: 135°C



# Surgical Handpiece

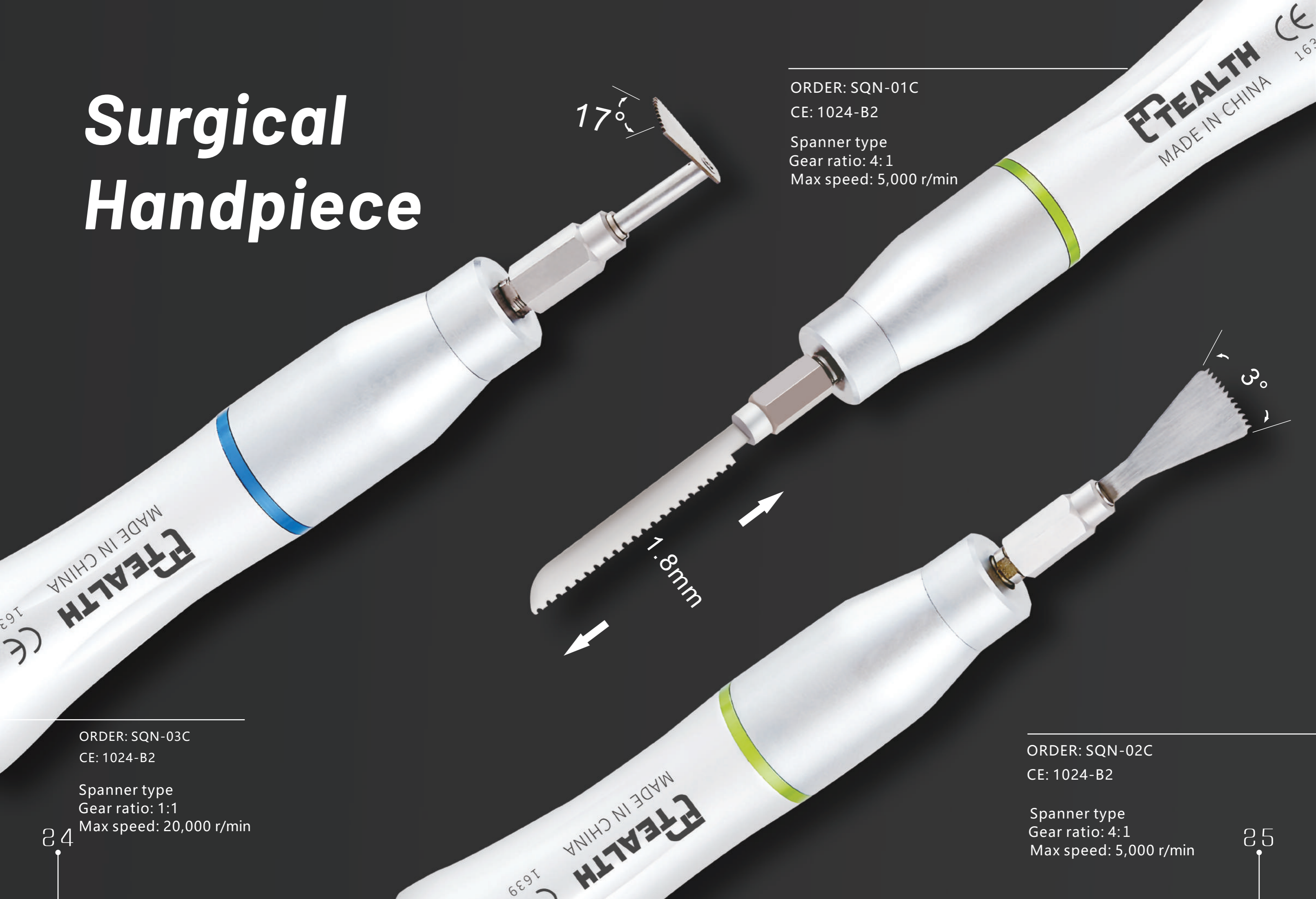

ORDER: SQN-01C

CE: 1024-B2

Spanner type

Gear ratio: 4:1

Max speed: 5,000 r/min

17°

1.8mm

25°

ORDER: SQN-03C

CE: 1024-B2

Spanner type

Gear ratio: 1:1

Max speed: 20,000 r/min

24

ORDER: SQN-02C

CE: 1024-B2

Spanner type

Gear ratio: 4:1

Max speed: 5,000 r/min

25



**Reciprocating interproximal stripping contra angle**

# IPR-02C 4:1 IPR contra angle

CE: 1021-M4

- Gear ratio: 4:1
- Stroke: 1.4mm
- Rotation speed: 10,000r/min



# S-11 Metal strips IPR kit

CE: 1021-M4

- 4:1 IPR contra angle: 1 pcs
- Metal Strips: 10 pcs (15 $\mu$ /25 $\mu$ /40 $\mu$ /60 $\mu$ /90 $\mu$  Each type 2 pcs)
- Gauge: 1 pcs
- Holder: 1 pcs
- Pushrod: 1 pcs



# S-12 Plastic strips IPR kit

CE: 1021-M4

- 4:1 IPR contra angle: 1 pcs
- Plastic Strips: 9 pcs (Serrated saw: 1 pcs, Fine: 2 pcs, Medium: 3 pcs, Coarse: 3 pcs)
- Gauge: 1 pcs
- Holder: 1 pcs
- Pushrod: 1 pcs



**Metal strip**



ORDER: C-SB  
CE: M-SS

07 micron - serrated saw



ORDER:  
left: CL-15  
right: CR-15  
double: C-15  
CE: M-15

15 micron - for pre polishing



ORDER:  
left: CL-25  
right: CR-25  
double: C-25  
CE: M-25

25 micron - for finishing



ORDER:  
left: CL-40  
right: CR-40  
double: C-40  
CE: M-40

40 micron - for contouring



ORDER:  
left: CL-60  
right: CR-60  
double: C-60  
CE: M-60

60 micron - for reducing



ORDER:  
left: CL-90  
right: CR-90  
double: C-90  
CE: M-90

90 micron - for opening contacts



ORDER: L8-02

**Plastic strip**

ORDER:  
CE:

**· Serrated saw**

01



I-SS  
P-SS

02



I-FR  
P-FR

I-FL  
P-FL

**· Fine**

03

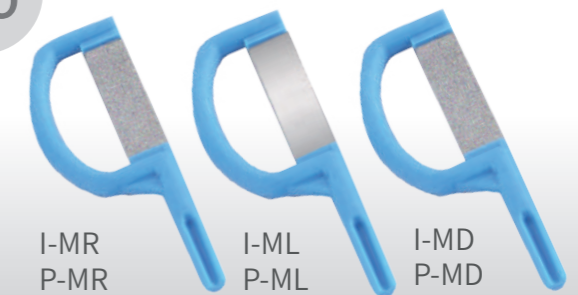

I-MR  
P-MR

I-ML  
P-ML

I-MD  
P-MD

**· Medium**

03



I-CL  
P-CL

I-CR  
P-CR

I-CD  
P-CD

**· Coarse**

# R16N-51C

## 16: 1 Endo hand file contra angle CE: 3040CH

- 16:1 Reduction contra angle
- Chuck type: Push button
- Internal spray Fit for E type motor
- Applicable bur:  $\phi 2.35\text{mm}$
- Rotation speed: 2,500r/min
- Detachable head-- Fit for hand file



- Fit for Hand file
- Order:L6-06



- Fit for K file
- Order:L6-01



- Fit for hand file
- Order:L6-07

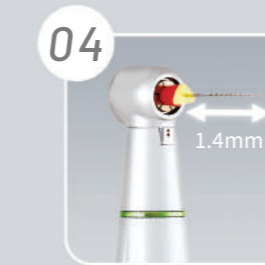

- Fit for hand file
- Order:L6-08

# R04N-41C

CE: 3040CH



## 4: 1 Reduction

- Internal spray
- Chuck type: Key type
- Fit for E type motor
- Applicable bur: Strip
- Rotation speed: 10,000RPM



**Contra Angle**

ORDER: R04F-01C  
CE: 3040CH

 FIBER OPTIC  
Push button  
CA  $\Phi$  2.35mm  
Max speed: 5,000 r/min



**Contra Angle**

ORDER: R04N-01C  
CE: 3040CH

Push button  
CA  $\Phi$  2.35mm  
Max speed: 5,000 r/min



**Contra Angle**

ORDER: R16N-01C  
CE: 3040CH

Push button  
CA  $\Phi$  2.35mm  
Max speed: 2,500 r/min

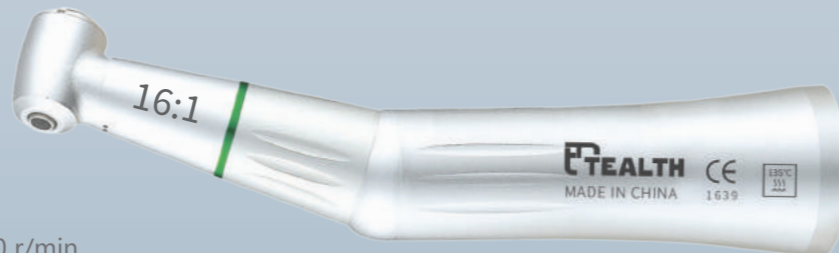

**Endo Contra Angle**

ORDER: R04N-51C  
CE: 3040CH

Push button  
Max speed: 5,000 r/min  
Hand use files



**Contra Angle**

ORDER: RE04N-05C  
CE: 1021-M4

Push button  
CA  $\Phi$  2.35mm  
Max speed: 5,000 r/min



**Endo Contra Angle**

ORDER: RE04N-03C  
CE: 1021-M4

Push button  
Max speed: 5,000 r/min  
Hand use files



**Polish Contra Angle**

ORDER: RE04N-04C  
CE: 1021-M4

For screw type prophylaxis cup  
Max speed: 5,000 r/min



## Titanium Colour High speed dental handpiece

Standard Head:  Order:SPN4-G-M4  Order:SPN4-G-B2

Torque Head:  Order:TPN4-G-M4  Order:TPN4-G-B2 CE: 2300P-B2

- Four water Spray
- Chuck type: Push button
- Stainless steel
- Rotation speed: 360,000-400,000r/min

## NSK Style Quick Coupling Handpiece TPF4-J-N6

CE: 2300PQL-M4

- Four water sprays
- Fiber optic
- Chuck type: Push button
- Rotation speed: 380,000-420,000r/min

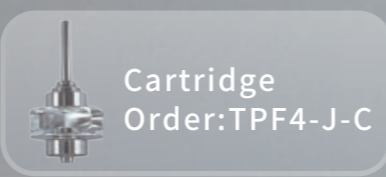



Cartridge  
Order: TPF4-J-C



Cartridge  
Order:  
• Torque: TPL3-A-C  
• Standard: SPL3-A-C



-  SPL3-A-M4
-  SPL3-A-B2

## LED High Speed Handpiece

CE: 23001PL-M4

- Chuck type: Push button  $\Phi$ 1.60mm
- Rotation speed: 360,000-400,000r/min

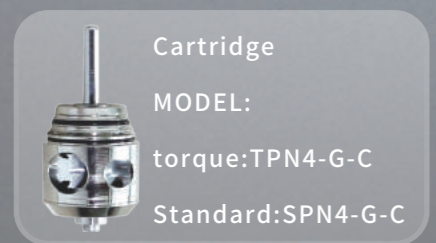

Cartridge  
MODEL:  
torque: TPN4-G-C  
Standard: SPN4-G-C



## Kavo Style Fiber Optic Quick Coupling Handpiece TPF3-U-K6

CE: 2300PQL-M4

- Fiber optic Torque Head
- Chuck type: Push button
- Kavo type quick coupling Triple water spray
- Torque Head rotation speed: 360,000-400,000r/min



36

## High speed dental Handpiece

Torque Head:  Order:TPN1-V-M4  Order:TPN1-V-B2

Standard Head:  Order:SPN1-V-M4  Order:SPN1-V-B2

CE: 2305P-M4

- Single water spray
- Chuck type: Push button
- rotation speed: 360,000-400,000r/min
- standard /torque head for choice

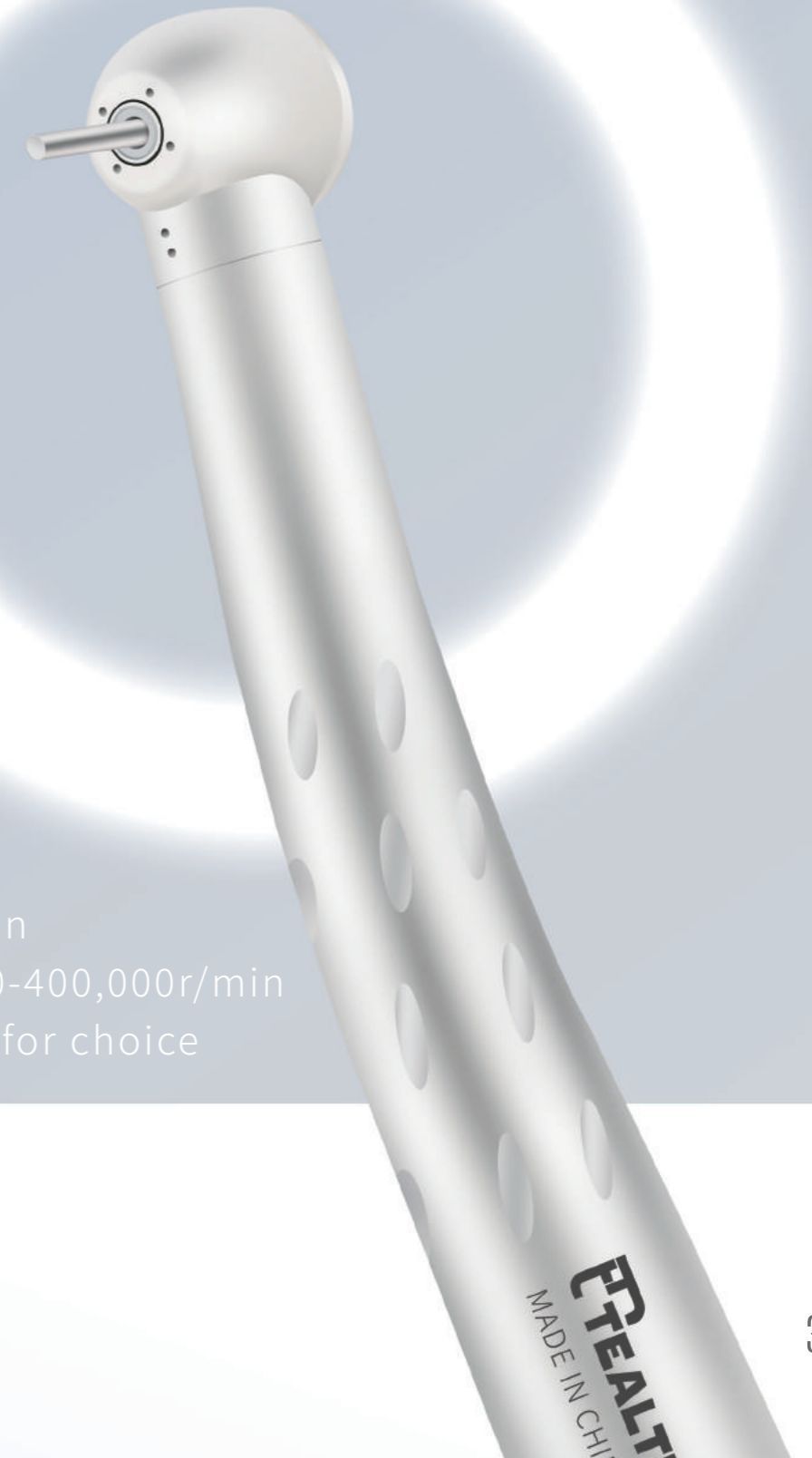

37

## 45° Stainless Steel LED High Speed Handpiece

CE: 2300PL-45

- Single water spray
- Rotation speed: 360,000-400,000r/min

☪ 45SPL-H-M4  
☪ 45SPL-H-B2

- Chuck type: Push button
- 45 Degree surgical

- Professional LED light source superior brightness



Cartridge  
Order: 45SPL-H-C

## 45° High Speed Handpiece

CE: 2300P-45B

☪ 45SPN-B-M4  
☪ 45SPN-B-B2

- Extended burs available

- Anti back suction

- Single water spray accurate cooling the tip of bur

FF HEALTH  
MADE IN CHINA

FF HEALTH  
MADE IN CHINA  
1639 CE



# Mini High Speed Handpiece

- MPN1-C-M4
- MPN1-C-B2

CE: 2303PL-B2

- Single water spray
- Mini head
- Chuck type: Push button
- Anti back suction
- Rotation speed: 360,000-400,000r/min



# Mini LED High Speed Handpiece

- MPL1-C-M4
- MPL1-C-B2

CE: 2303PL-M4

- E-generator, Self-illuminated
- Anti back suction
- Single water spray
- Chuck type: Push button
- Rotation speed: 360,000-400,000r/min





# High speed dental handpiece

CE: 2300PL-M4

## New LED High Speed Handpiece

☯ TPL3-U-M4 ☯ TPL3-U-B2

Durable Quiet Stable

• Professional LED light source, superior brightness

• Triple water spray perfect cooling

## Non-light High Speed Handpiece

☯ TPN3-U-M4  
☯ TPN3-U-B2

CE: 2300P-B2

- Noise:  $\leq 60$ dB
- Head size: 12.5mm
- Head height: 13.3mm
- Chuck type: Push button
- Rotation speed: 350,000-420,000r/min



• Lower head height better visibility

13.3mm

• Torque head more strong more durable

• Less than 60dB more quiet



# DIL-02C

## Brushless electric micromotor

CE: 3050EM-1

- Torque:3.2N.cm
- Rotation speed:2,000-40,000r/min
- 16:1/1:1/1:5 for choice



# D1L-03C *Electric Micromotor*

CE: 3050EM-1

- Torque:3.4N.cm
- Rotation speed:2,000-40,000r/min
- 16:1/1:1/1:5 for choice
- Illuminate:LED(white light)
- Power input:AC100-240V
- Size:Φ22×L71mm



# 3050EM-1(A) *Surgical drive system*

CE: 3050EM-1

- Brushless motor
- Torque:3.2N.cm
- Rotation speed 0-50,000r/min
- Cooling water:0-100ml/min





# CEN-20C









## IMPLANT TORQUE WRENCH

CE: 3206CH





- Model code:3206CH
- Torque:5-35N.cm
- Chuck type: Latch type
- 6pcs screws
- Bur size:2.35mm



### Replaceable bur head (External irrigation)

 <p>ORDER L6-09 CA <math>\phi</math>2.35 Contra angle head</p>	 <p>ORDER: L6-16 CA <math>\phi</math>2.35 LED Contra angle head</p>	 <p>ORDERL: L6-17 CA <math>\phi</math>2.35 LED Contra angle head with tube</p>	
 <p>ORDER: L6-10 FG <math>\phi</math>1.60 Contra angle head</p>	 <p>MODEL: L6-11 CA <math>\phi</math>2.35 Contra angle head</p>	 <p>MODEL: L6-19 Forscrew type proghy cup Contra angle head</p>	
 <p>ORDER: L6-12 CA <math>\phi</math>2.35 Contra angle head</p>	 <p>ORDER: L6-18 hand use ples Endo Contra angle head</p>	 <p>ORDER: L6-14 CA <math>\phi</math>2.35 Contra angle head</p>	 <p>ORDER:L6-20 For IPR strip IPR Contra angle head</p>

### Replaceable bur head (Internal irrigation)

 <p>ORDER: L6-01 for kavo(CA2.35) CA bur head (Max20,000r/min)</p>	 <p>ORDER: L6-02 for kavo(FG1.60) FG bur head (Max20,000r/min)</p>	 <p>ORDER: L6-03 for kavo(CA2.35) CA bur head (Max40,000r/min)</p>	 <p>ORDER: L6-04 for kavo(FG1.60) FG bur head (Max40,000r/min)</p>
---	---	---	---

### Repair tool

 <p>Lubrication Order:L8-01 GSJT-008</p>	 <p>Repair tool Order:L8-03</p>	 <p>Low speed handpiece repair tool Order:L8-06</p>
---	--	--